

HIGH EFFICIENT SINGLE INDUCTOR BUCK-BOOST CONVERTER WITH 2-A SWITCHES

FEATURES

- Up to 96% Efficiency
- 1200-mA Output Current at 3.3 V in Step Down Mode ($V_{IN} = 3.6\text{ V to }5.5\text{ V}$)
- Up to 800-mA Output Current at 3.3 V in Boost Mode ($V_{IN} > 2.4\text{ V}$)
- Automatic Transition between Step Down and Boost Mode
- Device Quiescent Current less than $50\mu\text{A}$
- Input Voltage Range: 2 V to 5.5 V
- Fixed and Adjustable Output Voltage Options from 1.2 V to 5.5 V
- Power Save Mode for Improved Efficiency at Low Output Power
- Forced Fixed Frequency Operation and Synchronization possible
- Load Disconnect During Shutdown
- Overtemperature Protection
- Available in Small 20 pin 2.14 mm x 1.93 mm, WCSP Package

APPLICATIONS

- All Two-Cell and Three-Cell Alkaline, NiCd or NiMH or Single-Cell Li Battery Powered Products
- Portable Audio Players
- PDAs
- Cellular Phones
- Personal Medical Products
- White LEDs

DESCRIPTION

The TPS6301x devices provide a power supply solution for products powered by either a two-cell or three-cell alkaline, NiCd or NiMH battery, or a one-cell Li-Ion or Li-polymer battery. Output currents can go as high as 1200 mA while using a single-cell Li-Ion or Li-Polymer Battery, and discharge it down to 2.5 V or lower. The buck-boost converter is based on a fixed frequency, pulse-width-modulation (PWM) controller using synchronous rectification to obtain maximum efficiency. At low load currents, the converter enters Power Save mode to maintain high efficiency over a wide load current range. The Power Save mode can be disabled, forcing the converter to operate at a fixed switching frequency. The maximum average current in the switches is limited to a typical value of 2200 mA. The output voltage is programmable using an external resistor divider, or is fixed internally on the chip. The converter can be disabled to minimize battery drain. During shutdown, the load is disconnected from the battery. The device is packaged in a 20-pin WCSP package measuring 2.14 mm x 1.93 mm (YFF).

Typical Application Circuit

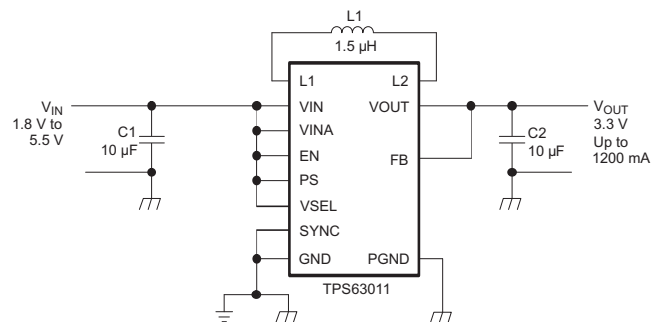

Please be aware that an important notice concerning availability, standard warranty, and use in critical applications of Texas Instruments semiconductor products and disclaimers thereto appears at the end of this data sheet.

These devices have limited built-in ESD protection. The leads should be shorted together or the device placed in conductive foam during storage or handling to prevent electrostatic damage to the MOS gates.

AVAILABLE OUTPUT VOLTAGE OPTIONS⁽¹⁾

T _A	OUTPUT VOLTAGE DC/DC at VSEL = 1	OUTPUT VOLTAGE DC/DC at VSEL = 0	PACKAGE MARKING	PACKAGE	PART NUMBER ⁽²⁾
- 40°C to 85°C	Adjustable	Adjustable	TPS63010	20-Pin WCSP	TPS63010YFF
	3.3 V	2.8 V	TPS63011		TPS63011YFF
	3.4 V	2.9 V	TPS63012		TPS63012YFF

- (1) Contact the factory to check availability of other fixed output voltage versions.
- (2) The YFF package is available taped and reeled. Add R suffix to device type (e.g., TPS63010YFFR) to order quantities of 3000 devices per reel. Add T suffix to device type (e.g., TPS63010YFFT) to order quantities of 250 devices per reel.

ABSOLUTE MAXIMUM RATINGS

over operating free-air temperature range (unless otherwise noted)⁽¹⁾

		TPS6301x	UNITS
V _I	Input voltage range on VIN, VINA, VINA1, L1, L2, VOUT, PS, SYNC, VSEL, EN, FB	- 0.3 to 7	V
T _J	Operating junction temperature range	- 40 to 150	°C
T _{stg}	Storage temperature range	- 65 to 150	
ESD Voltage	Human Body Model (HBM) ⁽²⁾	2.5	kV
	Machine Model (MM) ⁽²⁾	150	V
	Charged Device Model (CDM) ⁽²⁾	1	kV

- (1) Stresses beyond those listed under "absolute maximum ratings" may cause permanent damage to the device. These are stress ratings only, and functional operation of the device at these or any other conditions beyond those indicated under "recommended operating conditions" is not implied. Exposure to absolute-maximum-rated conditions for extended periods may affect device reliability.
- (2) ESD testing is performed according to the respective JEDEC standard.

DISSIPATION RATINGS TABLE

PACKAGE ⁽¹⁾	THERMAL RESISTANCE θ _{JA}	POWER RATING T _A ≤ 25°C	DERATING FACTOR ABOVE T _A = 25°C
YFF	84 °C/W	1190 mW	12 mW/°C

- (1) For the most current package and ordering information, see the Package Option Addendum at the end of this document, or see the TI website at www.ti.com.

RECOMMENDED OPERATING CONDITIONS

	MIN	NOM	MAX	UNIT
Supply voltage at VIN, VINA	2		5.5	V
Operating free air temperature range, T _A	- 40		85	°C
Operating junction temperature range, T _J	- 40		125	°C

ELECTRICAL CHARACTERISTICS

over recommended free-air temperature range and over recommended input voltage range (typical at an ambient temperature range of 25°C) (unless otherwise noted)

DC/DC STAGE							
PARAMETER		TEST CONDITIONS	MIN	TYP	MAX	UNIT	
V_I	Input voltage range		2		5.5	V	
V_I	Input voltage range for startup		2.1		5.5	V	
V_O	TPS63010 output voltage range		1.2		5.5	V	
V_{FB}	TPS63010 feedback voltage	$0^\circ\text{C} \leq T_A \leq 60^\circ\text{C}$	492.5	500	503.5	mV	
V_{FB}	TPS63010 feedback voltage		489	500	507	mV	
	TPS63011 output voltage	VSEL = LOW, $0^\circ\text{C} \leq T_A \leq 60^\circ\text{C}$	2.758	2.8	2.842	V	
	TPS63011 output voltage	VSEL = LOW	2.750	2.8	2.850	V	
	TPS63011 output voltage	VSEL = HIGH, $0^\circ\text{C} \leq T_A \leq 60^\circ\text{C}$	3.251	3.3	3.350	V	
	TPS63011 output voltage	VSEL = HIGH	3.241	3.3	3.359	V	
	TPS63012 output voltage	VSEL = LOW, $0^\circ\text{C} \leq T_A \leq 60^\circ\text{C}$	2.857	2.9	2.944	V	
	TPS63012 output voltage	VSEL = LOW	2.848	2.9	2.952	V	
	TPS63012 output voltage	VSEL = HIGH, $0^\circ\text{C} \leq T_A \leq 60^\circ\text{C}$	3.349	3.4	3.451	V	
	TPS63012 output voltage	VSEL = HIGH	3.339	3.4	3.461	V	
f	Oscillator frequency		2200	2400	2600	kHz	
	Frequency range for synchronization		2200		3000	kHz	
I_{SW}	Switch current limit	$V_{IN} = V_{INA} = 3.6\text{ V}$, $T_A = 25^\circ\text{C}$	2000	2200	2400	mA	
	High side switch on resistance	$V_{IN} = V_{INA} = 3.6\text{ V}$		100		m Ω	
	Low side switch on resistance	$V_{IN} = V_{INA} = 3.6\text{ V}$		100		m Ω	
	Maximum line regulation	PS = HIGH		0.5%			
	Maximum load regulation	PS = HIGH		0.5%			
I_q	Quiescent current	VIN	$I_O = 0\text{ mA}$, $V_{EN} = V_{IN} = V_{INA} = 3.6\text{ V}$, $V_{OUT} = 3.3\text{ V}$		1	2	μA
		VINA			40	50	μA
		VOUT (adjustable output voltage version)			4	6	μA
	FB input impedance (fixed output voltage versions)			1		M Ω	
I_S	Shutdown current	VIN	$V_{EN} = 0\text{ V}$, $V_{IN} = V_{INA} = 3.6\text{ V}$		0.1	1	μA
		VINA	PS, SYNC, VSEL clamped on GND or VINA		0.1	1.5	μA

CONTROL STAGE						
PARAMETER		TEST CONDITIONS	MIN	TYP	MAX	UNIT
UVLO	Under voltage lockout threshold	V_{INA} voltage decreasing	1.5	1.7	1.8	V
V_{IL}	EN, PS, SYNC, VSEL input low voltage				0.4	V
V_{IH}	EN, PS, SYNC, VSEL input high voltage		1.2			V
	EN, PS, SYNC, VSEL input current	Clamped on GND or VINA		0.01	0.1	μA
	Overtemperature protection			140		$^\circ\text{C}$
	Overtemperature hysteresis			20		$^\circ\text{C}$

PIN ASSIGNMENTS

YFF PACKAGE (TOP VIEW)

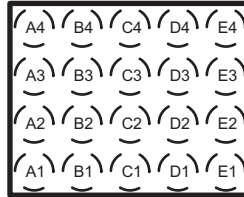

Terminal Functions

TERMINAL		I/O	DESCRIPTION
NAME	NO.		
EN	A4	I	Enable input. (1 enabled, 0 disabled)
FB	E3	I	Voltage feedback of adjustable versions, must be connected to VOUT at fixed output voltage versions
GND	C3, D3, E4		Control / logic ground
PS	C4	I	Enable / disable power save mode (1 disabled, 0 enabled)
L1	B1,B2	I	Connection for Inductor
L2	D1,D2	I	Connection for Inductor
PGND	C1,C2		Power ground
SYNC	B4	I	Clock signal for synchronization, should be connected to GND if not used
VSEL	D4	I	Output voltage select for fixed output voltage options (1 programs higher output voltage option, 0 programs lower output voltage option), must be connected to a defined logic signal at adjustable output voltage option.
VIN	A1, A2	I	Supply voltage for power stage
VINA	A3	I	Supply voltage for control stage
VINA1	B3	O	Output of the 100 Ω for designing the VINA filter
VOUT	E1,E2	O	Buck-boost converter output

FUNCTIONAL BLOCK DIAGRAM (TPS63010)

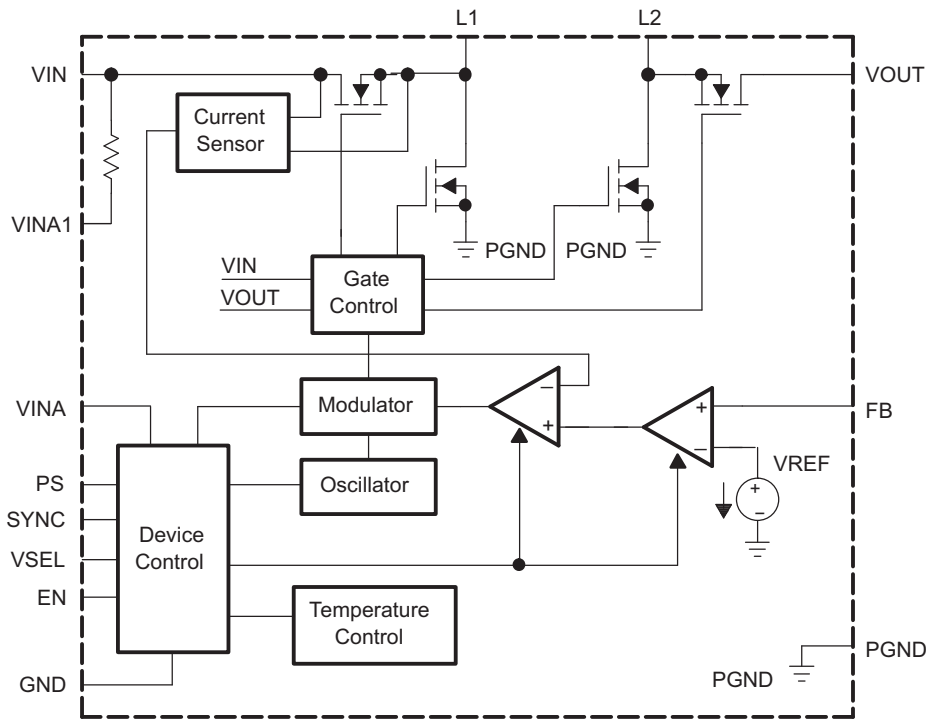

FUNCTIONAL BLOCK DIAGRAM (TPS63011, TPS63012)

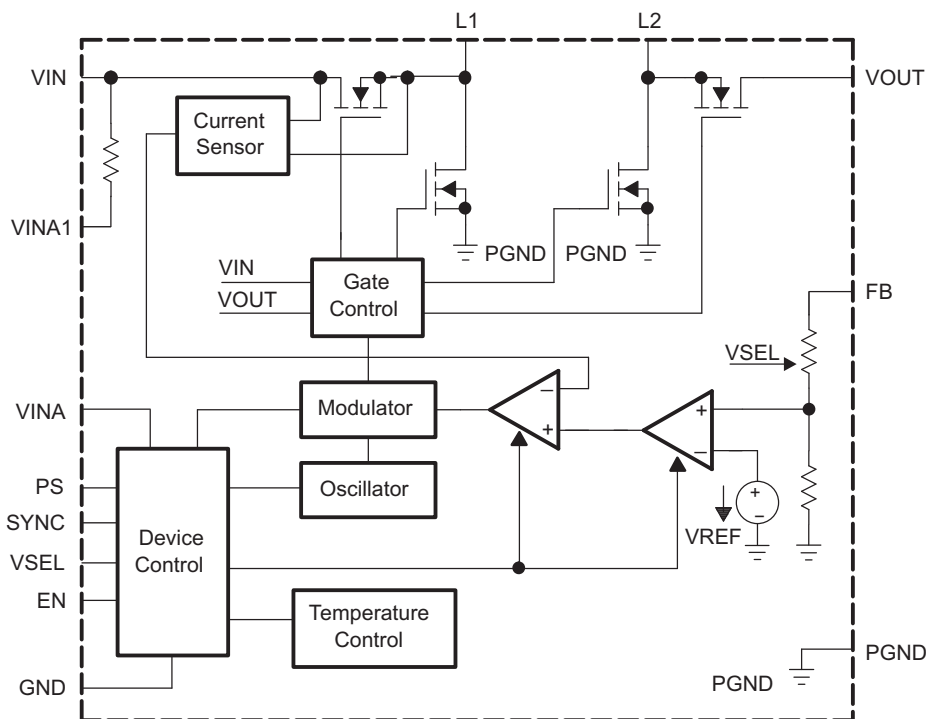

TYPICAL CHARACTERISTICS

Table of Graphs

		FIGURE	
Maximum output current	vs Input voltage (TPS63010, VOUT = 2.5 V / VOUT = 4.5 V)	1	
	vs Input voltage (TPS63011, VSEL = HIGH / VSEL = LOW)	2	
	vs Input voltage (TPS63012, VSEL = HIGH / VSEL = LOW)	3	
Efficiency	vs Output current (TPS63010, Power Save Enabled, VOUT = 2.5 V / VOUT = 4.5 V)	4	
	vs Output current (TPS63010, Power Save Disabled, VOUT = 2.5V / VOUT = 4.5V)	5	
	vs Output current (TPS63011, Power Save Enabled, VSEL = HIGH / VSEL = LOW)	6	
	vs Output current (TPS63011, Power Save Disabled, VSEL = HIGH / VSEL = LOW)	7	
	vs Output current (TPS63012, Power Save Enabled, VSEL = HIGH / VSEL = LOW)	8	
	vs Output current (TPS63012, Power Save Disabled, VSEL = HIGH / VSEL = LOW)	9	
	vs Input voltage (TPS63010, Power Save Enabled, VOUT = 2.5V, IOU = {10; 100; 500; 1000 mA})	10	
	vs Input voltage (TPS63010, Power Save Enabled, VOUT = 4.5V, IOU = {10; 100; 500; 1000 mA})	11	
	vs Input voltage (TPS63010, Power Save Disabled, VOUT = 2.5V, IOU = {10; 100; 500; 1000 mA})	12	
	vs Input voltage (TPS63010, Power Save Disabled, VOUT = 4.5V, IOU = {10; 100; 500; 1000 mA})	13	
	vs Input voltage (TPS63011, Power Save Enabled, VSEL = HIGH, IOU = {10; 100; 500; 1000 mA})	14	
	vs Input voltage (TPS63011, Power Save Enabled, VSEL = LOW, IOU = {10; 100; 500; 1000 mA})	15	
	vs Input voltage (TPS63011, Power Save Disabled, VSEL = HIGH, IOU = {10; 100; 500; 1000 mA})	16	
	vs Input voltage (TPS63011, Power Save Disabled, VSEL = LOW, IOU = {10; 100; 500; 1000 mA})	17	
	vs Input voltage (TPS63012, Power Save Enabled, VSEL = HIGH, IOU = {10; 100; 500; 1000 mA})	18	
	vs Input voltage (TPS63012, Power Save Enabled, VSEL = LOW, IOU = {10; 100; 500; 1000 mA})	19	
	vs Input voltage (TPS63012, Power Save Disabled, VSEL = HIGH, IOU = {10; 100; 500; 1000 mA})	20	
	vs Input voltage (TPS63012, Power Save Disabled, VSEL = LOW, IOU = {10; 100; 500; 1000 mA})	21	
	Waveforms	Load transient response (TPS63011, VIN < VOUT, VSEL = HIGH)	22
		Load transient response (TPS63011, VIN > VOUT, VSEL = HIGH)	23
		Load transient response (TPS63012, VIN < VOUT, VSEL = HIGH)	24
Load transient response (TPS63012, VIN > VOUT, VSEL = HIGH)		25	
Line transient response (TPS63011, VSEL = HIGH, Iout = 300 mA)		26	
Line transient response (TPS63012, VSEL = HIGH, Iout = 300 mA)		27	
Startup after enable (TPS63011, VSEL = HIGH)		28	
Startup after enable (TPS63012, VSEL = HIGH)		29	

**MAXIMUM OUTPUT CURRENT
vs
INPUT VOLTAGE
(TPS63010)**

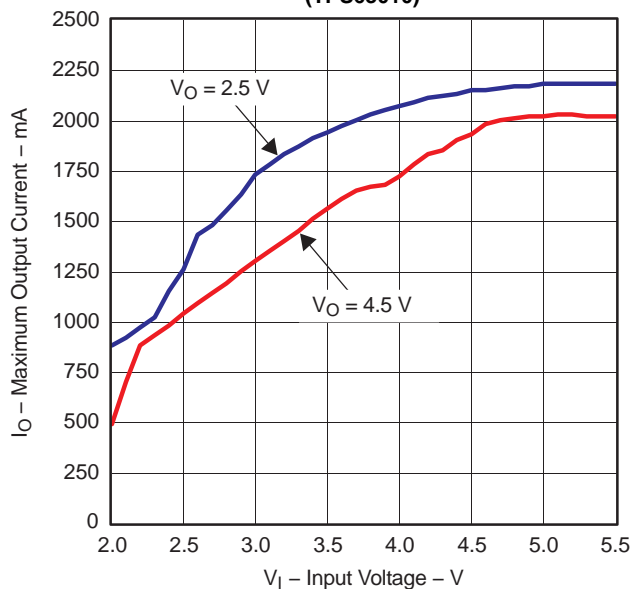

Figure 1.

G001

**MAXIMUM OUTPUT CURRENT
vs
INPUT VOLTAGE
(TPS63011)**

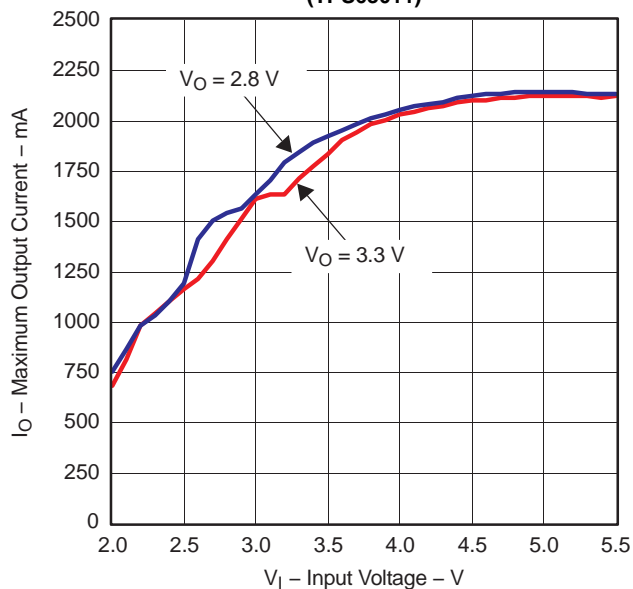

Figure 2.

G002

**MAXIMUM OUTPUT CURRENT
vs
INPUT VOLTAGE
(TPS63012)**

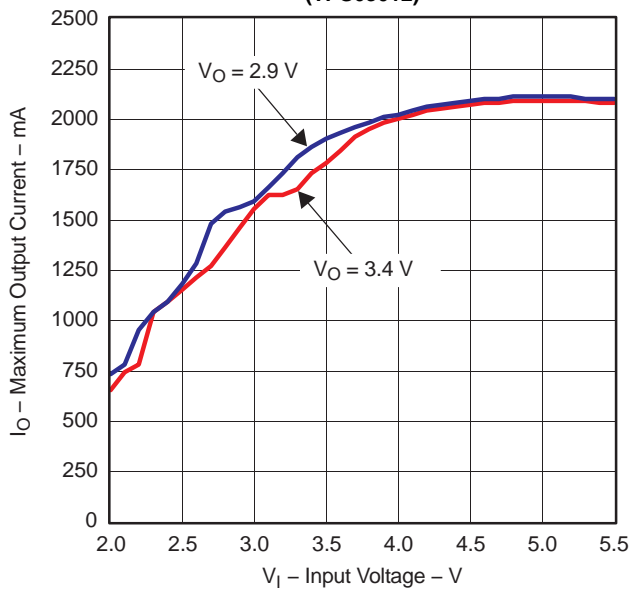

Figure 3.

G003

**EFFICIENCY
vs
OUTPUT CURRENT
(TPS63010)**

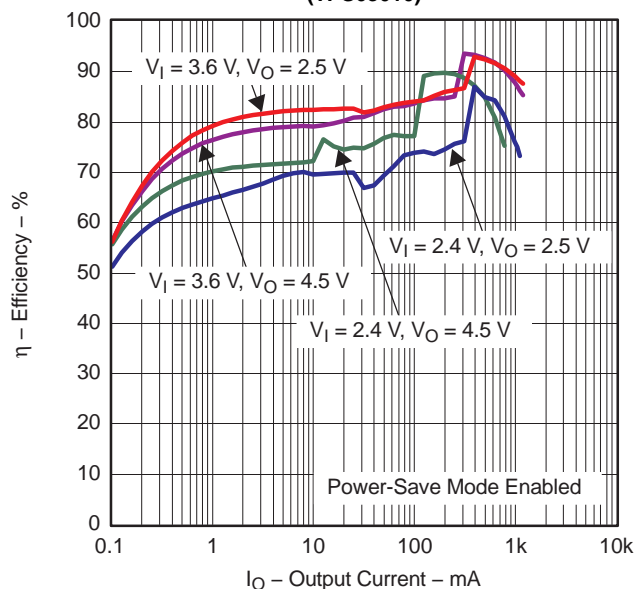

Figure 4.

G004

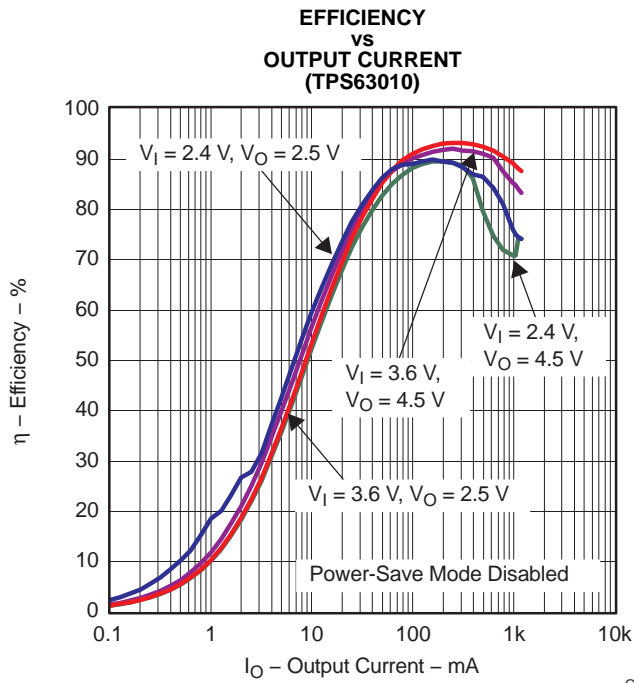

Figure 5.

G005

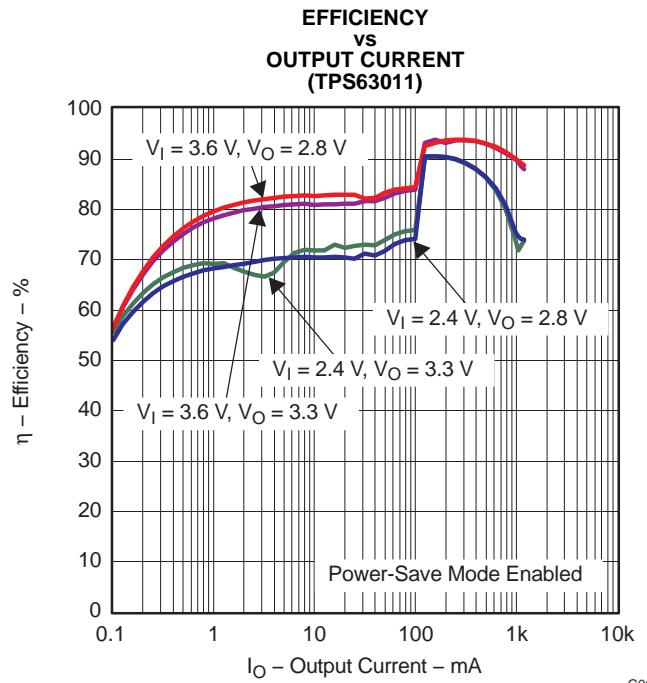

Figure 6.

G006

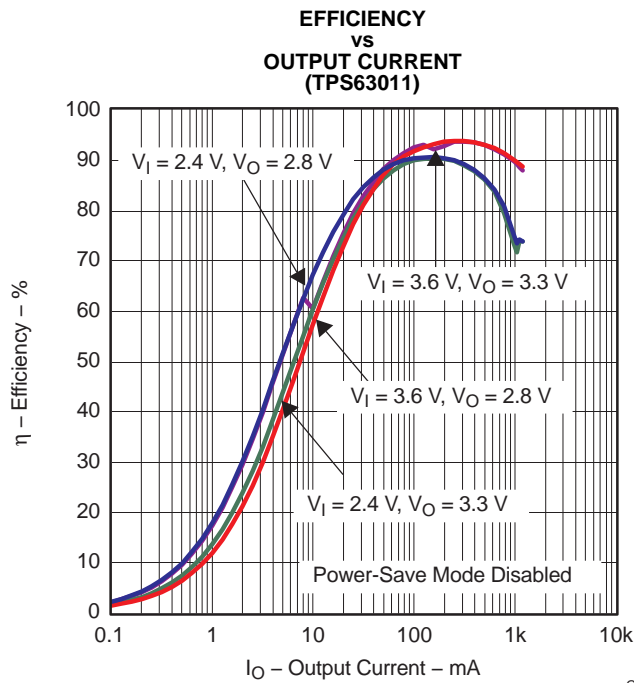

Figure 7.

G007

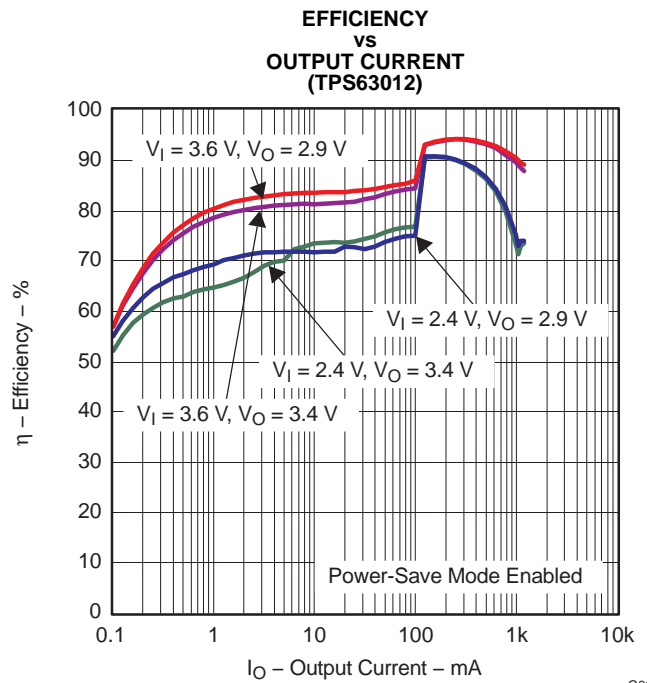

Figure 8.

G008

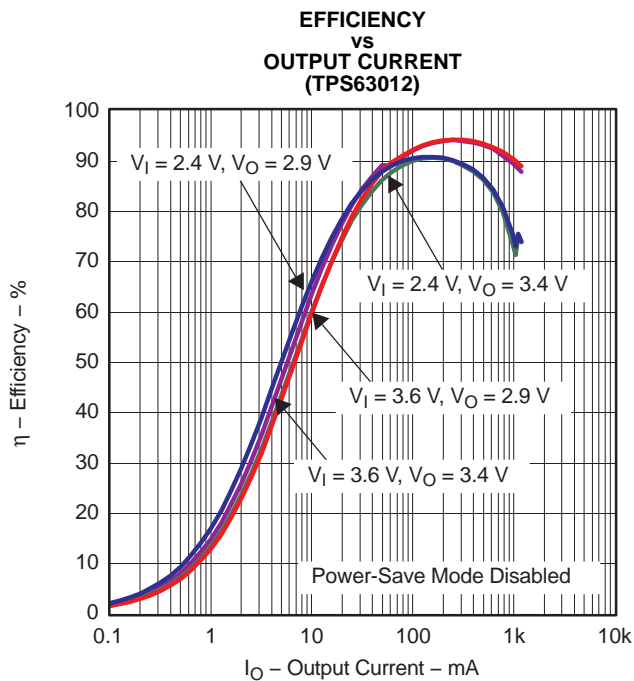

Figure 9.

G009

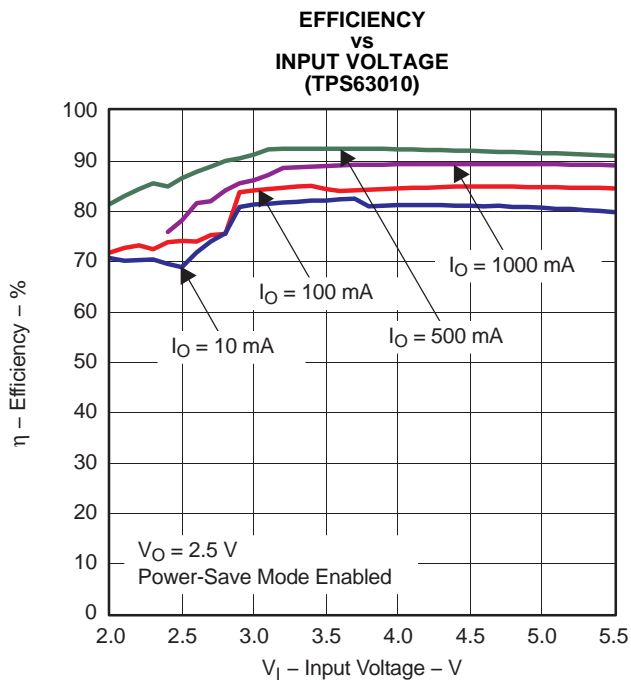

Figure 10.

G010

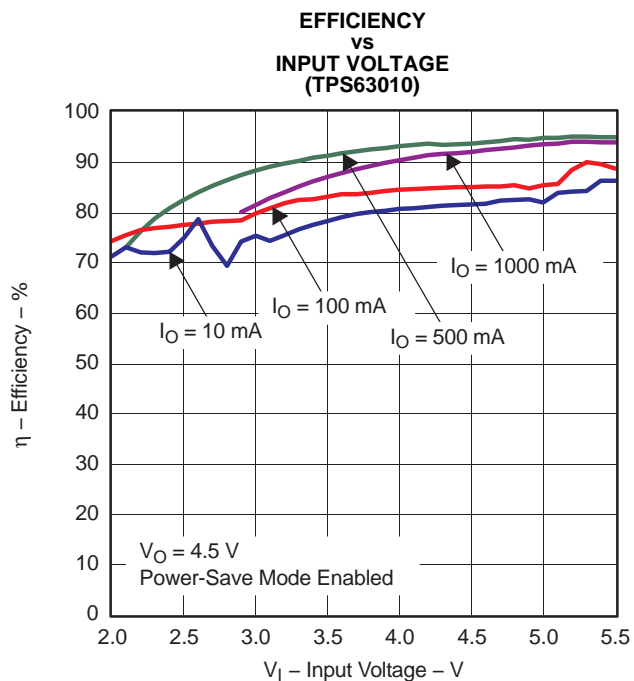

Figure 11.

G011

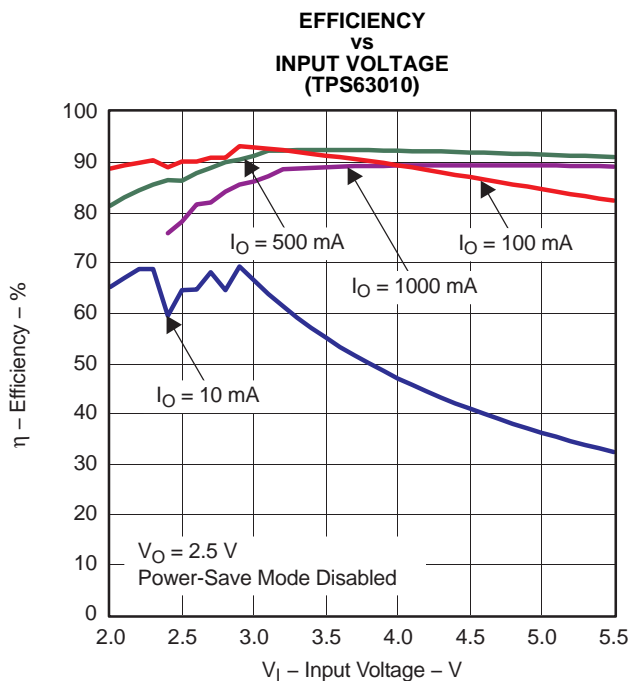

Figure 12.

G012

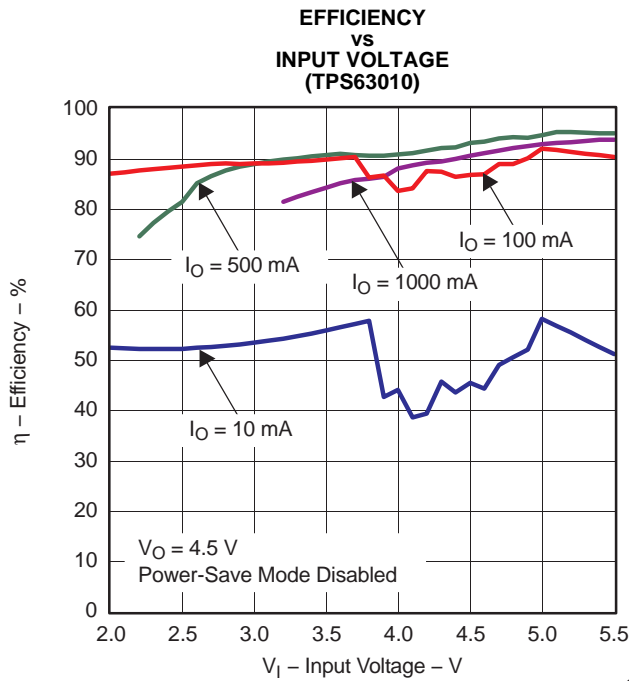

Figure 13.

G013

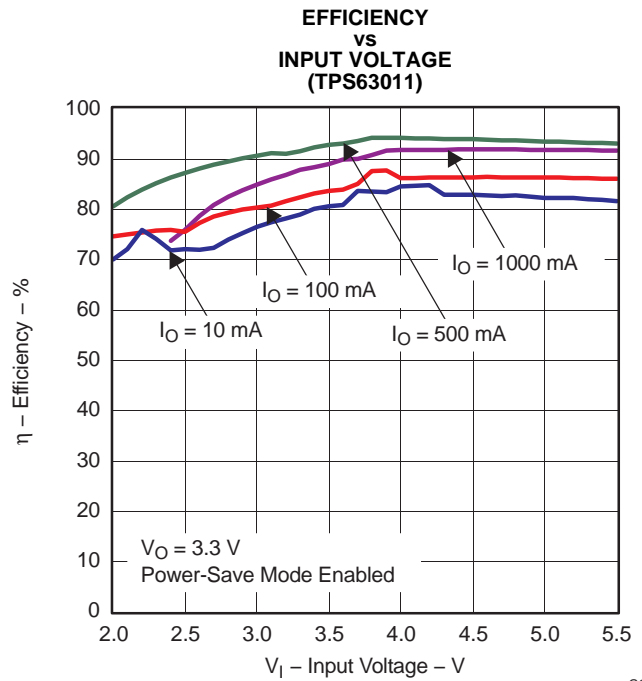

Figure 14.

G014

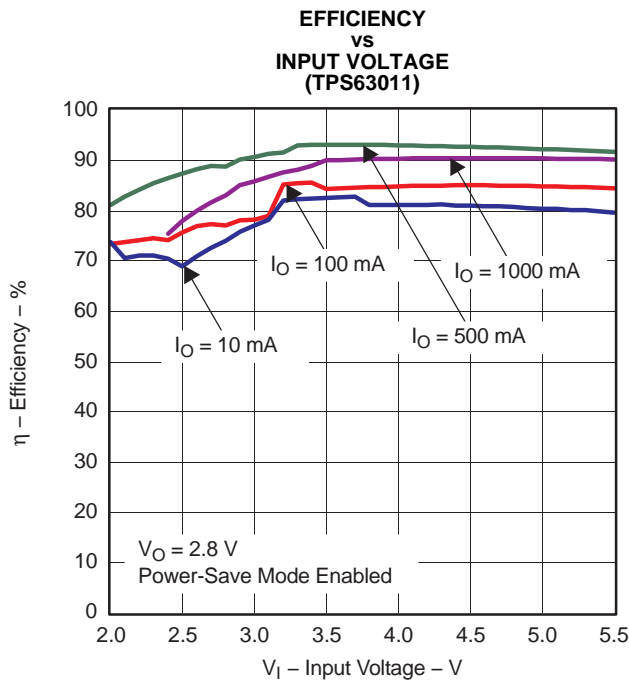

Figure 15.

G015

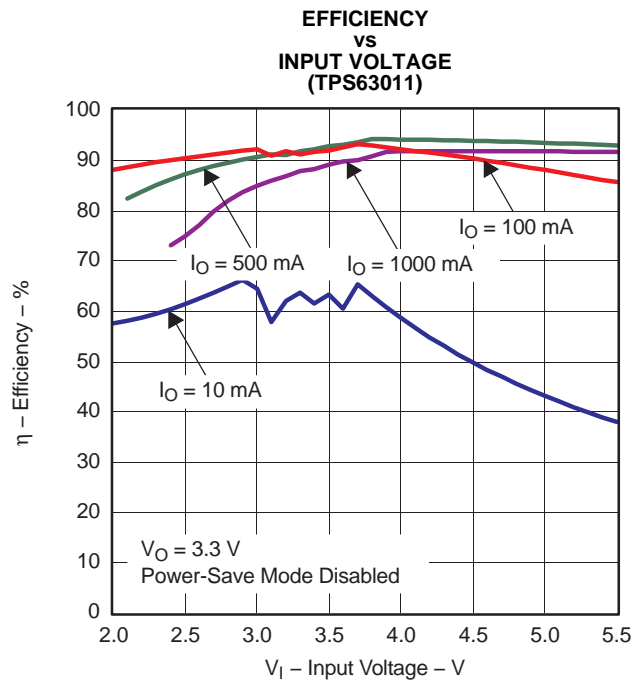

Figure 16.

G016

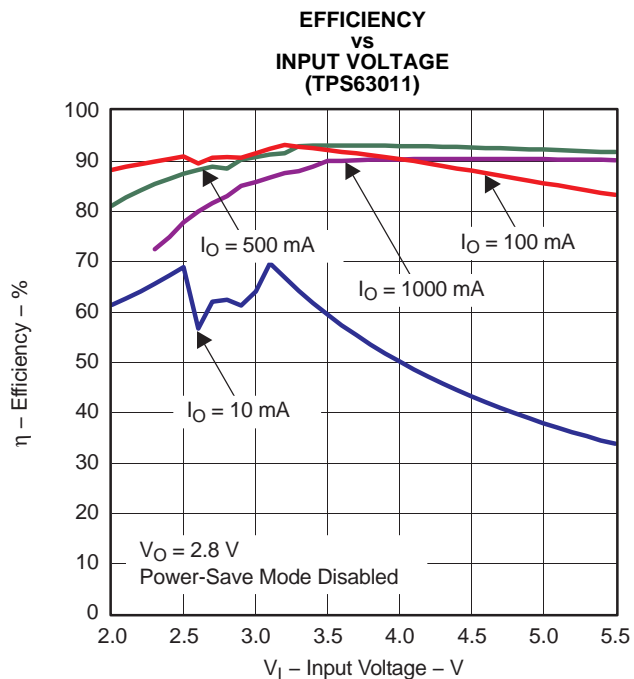

Figure 17.

G017

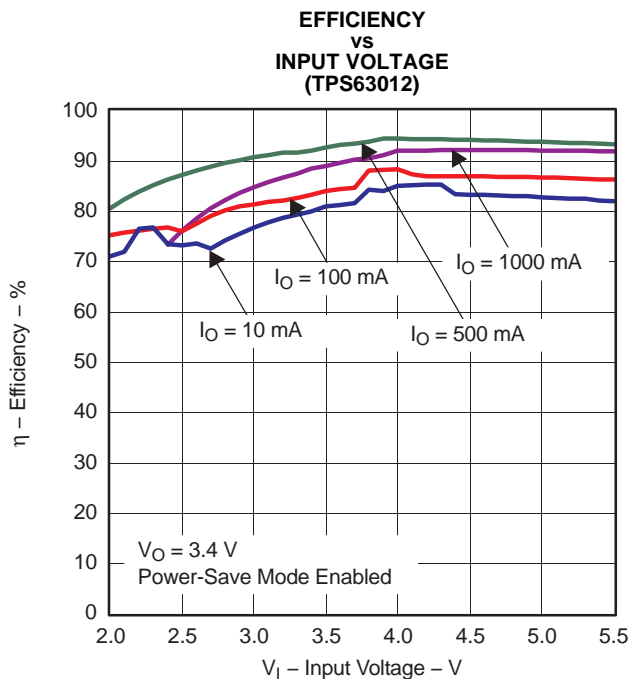

Figure 18.

G018

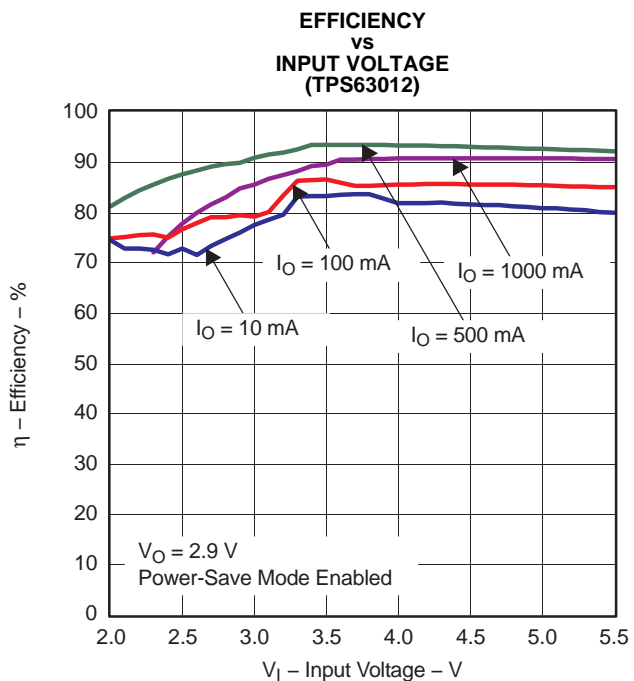

Figure 19.

G019

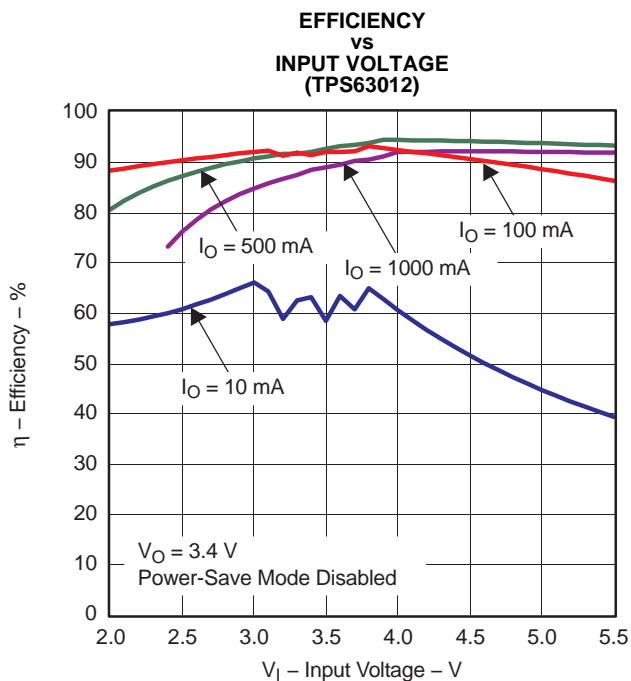

Figure 20.

G020

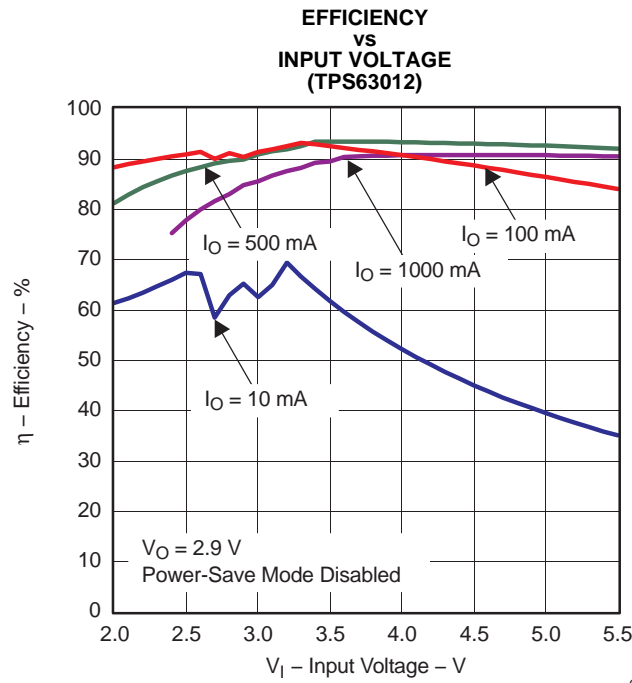

Figure 21.
**LOAD TRANSIENT RESPONSE
 (TPS63011)**

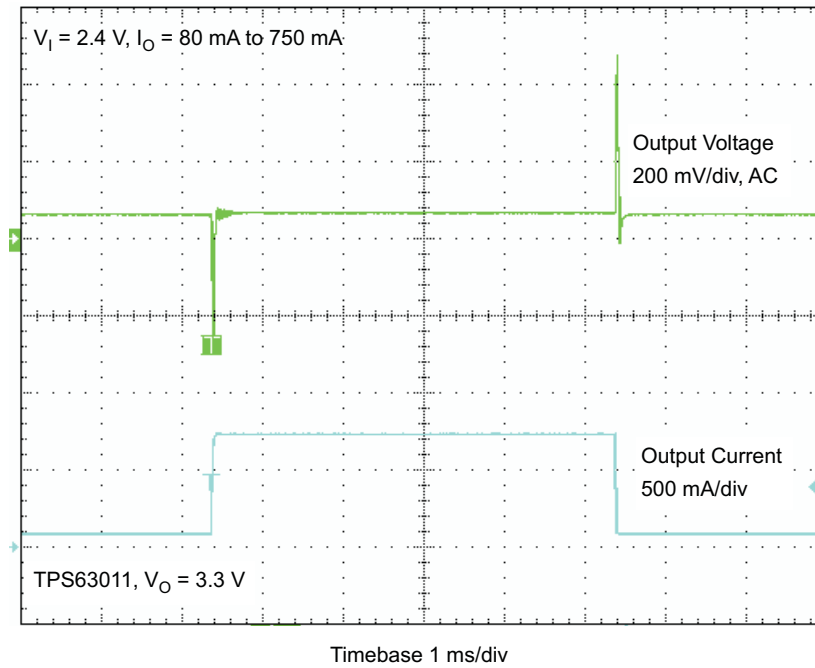
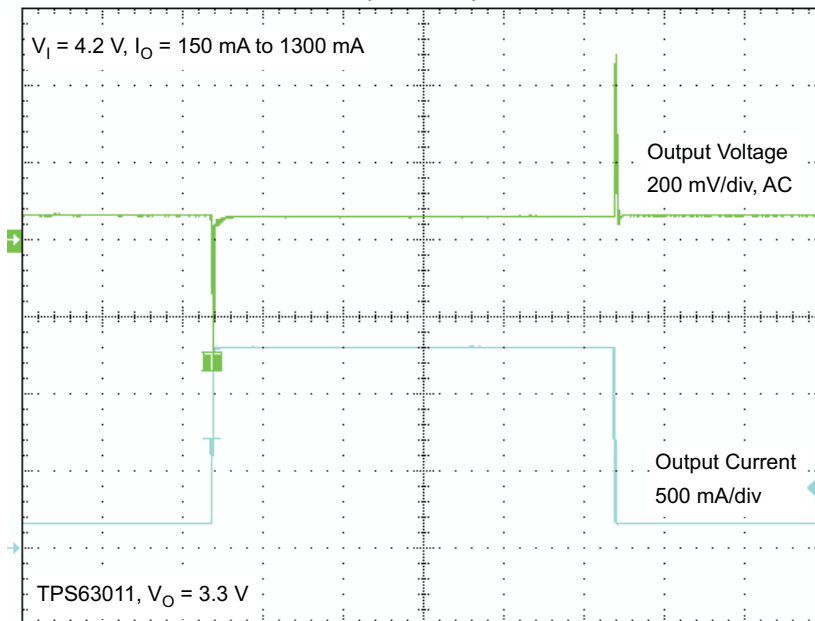

Figure 22.

LOAD TRANSIENT RESPONSE
(TPS63011)



Timebase 1 ms/div

G029

Figure 23.

LOAD TRANSIENT RESPONSE
(TPS63012)

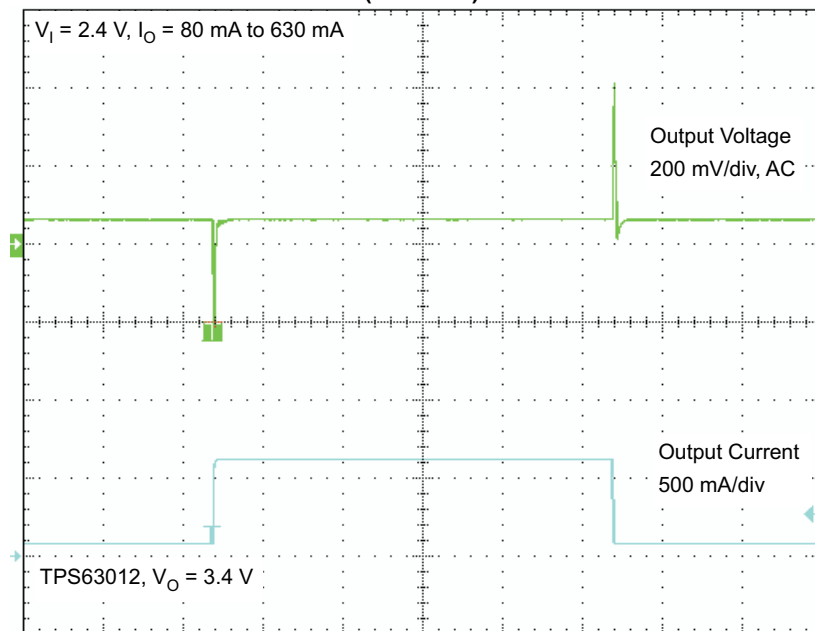

Timebase 1 ms/div

G030

Figure 24.

LOAD TRANSIENT RESPONSE
(TPS63012)

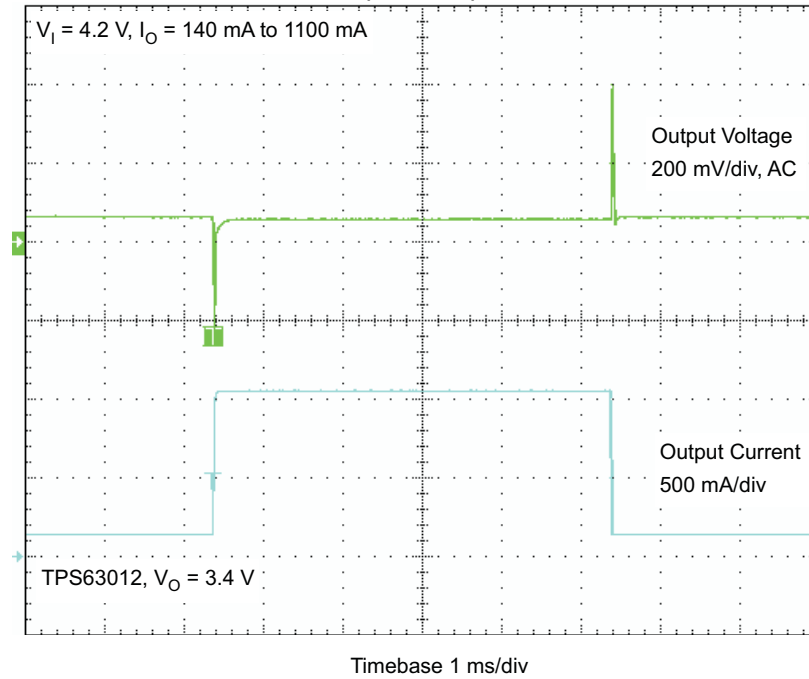

Figure 25.

G031

LINE TRANSIENT RESPONSE
(TPS63011)

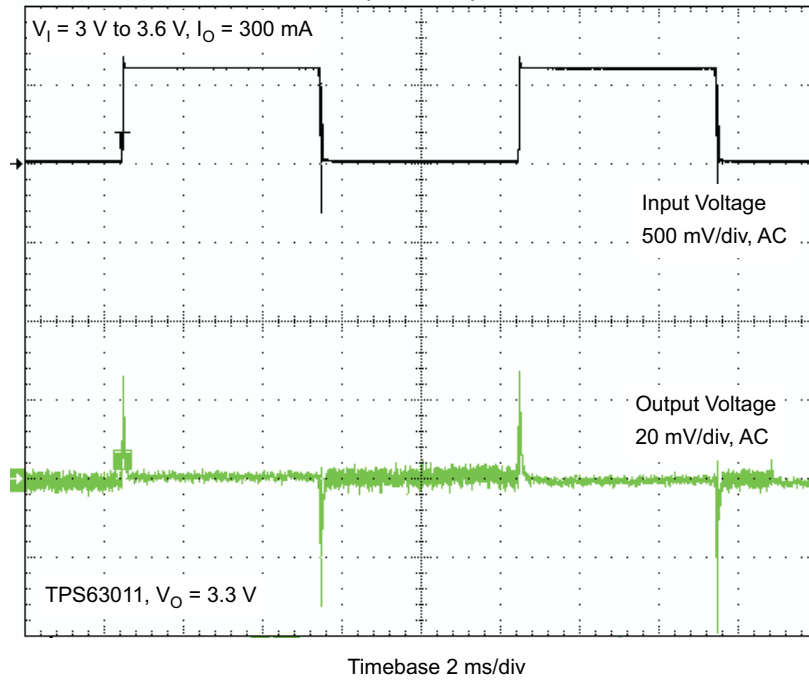
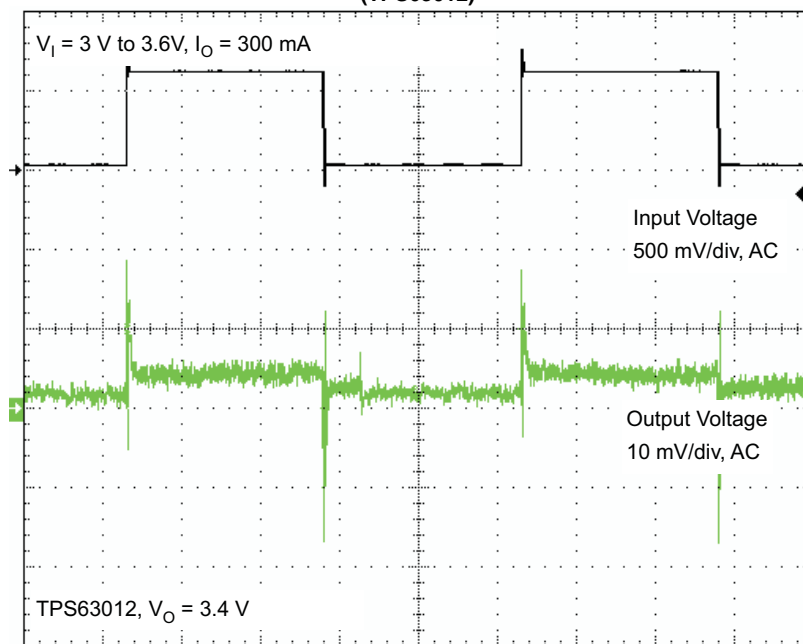

Figure 26.

G032

LINE TRANSIENT RESPONSE
(TPS63012)



Timebase 2 ms/div

G033

Figure 27.

START-UP AFTER ENABLE
(TPS63011)

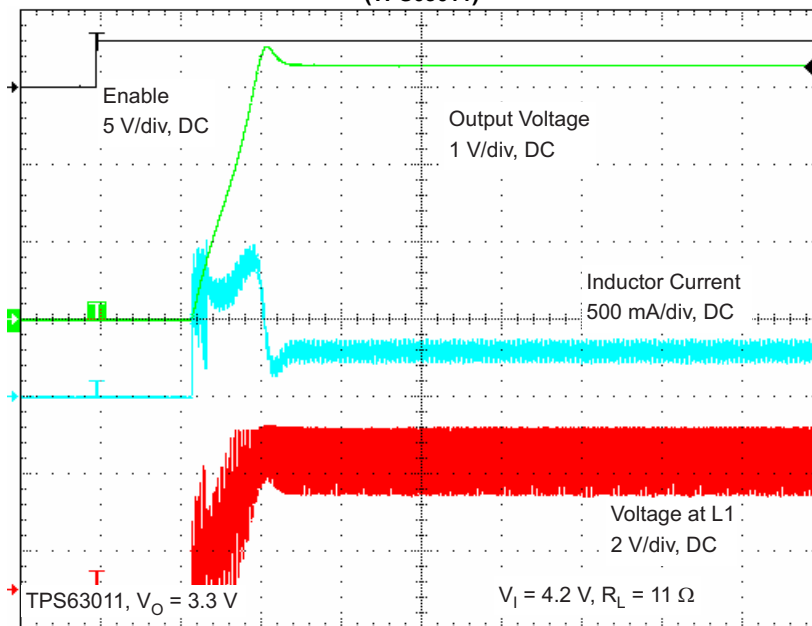

Timebase 100 $\mu\text{s}/\text{div}$

G034

Figure 28.

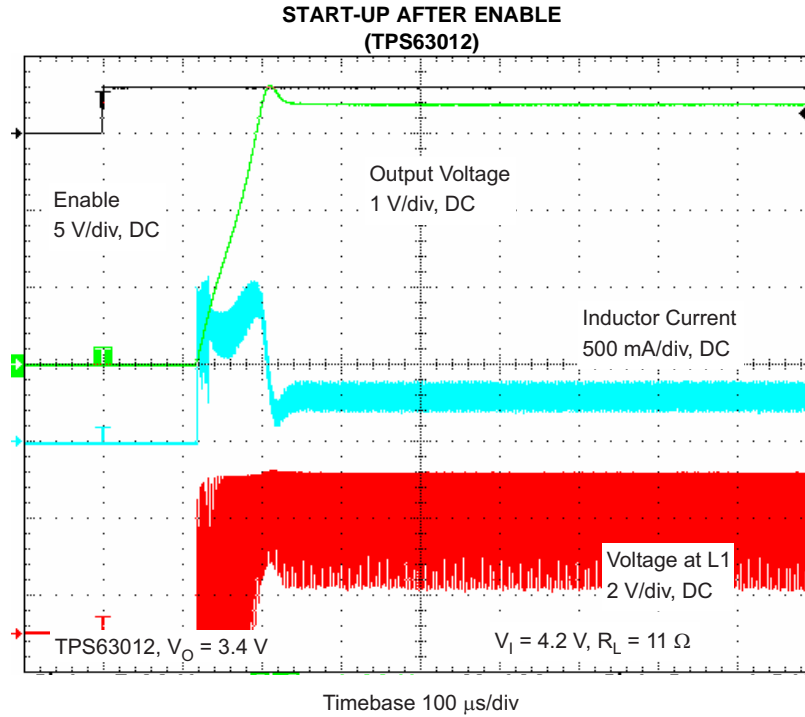
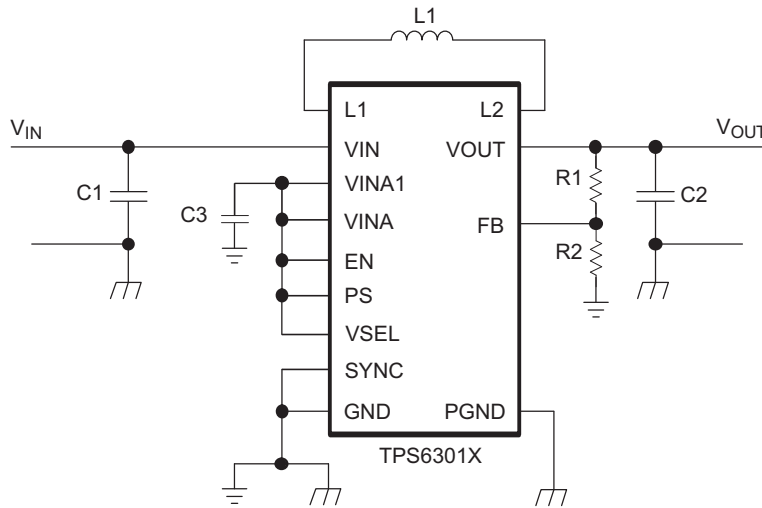

Figure 29.

G035

PARAMETER MEASUREMENT INFORMATION



List of Components

REFERENCE	DESCRIPTION	MANUFACTURER
	TPS6301 0 / 1 / 2	Texas Instruments
L1	LPS3015-222	Coilcraft
C1	GRM188R60J106M (10 μ F 6.3V, 0603)	Murata
C2	2 \times GRM188R60J106M (10 μ F 6.3V, 0603)	Murata
C3	0.1 μ F, X7R ceramic	

PARAMETER MEASUREMENT INFORMATION (continued)**List of Components (continued)**

REFERENCE	DESCRIPTION	MANUFACTURER
R1, R2	Depending on the output voltage at TPS63010, not used at TPS6301 1 / 2 (R1 shorted)	

DETAILED DESCRIPTION

CONTROLLER CIRCUIT

The controlling circuit of the device is based on an average current mode topology. The average inductor current is regulated by a fast current regulator loop which is controlled by a voltage control loop. The controller also uses input and output voltage feedforward. Changes of input and output voltage are monitored and immediately can change the duty cycle in the modulator to achieve a fast response to those errors. The voltage error amplifier gets its feedback input from the FB pin. At adjustable output voltages a resistive voltage divider must be connected to that pin. At fixed output voltages FB must be connected to the output voltage to directly sense the voltage. Fixed output voltage versions use a trimmed internal resistive divider. The feedback voltage will be compared with the internal reference voltage to generate a stable and accurate output voltage.

The controller circuit also senses the average input current as well as the peak input current. With this, maximum input power can be controlled as well as the maximum peak current to achieve a safe and stable operation under all possible conditions. To finally protect the device from overheating, an internal temperature sensor is implemented.

Synchronous Operation

The device uses 4 internal N-channel MOSFETs to maintain synchronous power conversion at all possible operating conditions. This enables the device to keep high efficiency over a wide input voltage and output power range.

To avoid ground shift problems due to the high currents in the switches, two separate ground pins GND and PGND are used. The reference for all control functions is the GND pin. The power switches are connected to PGND. Both grounds must be connected on the PCB at only one point ideally close to the GND pin. Due to the 4-switch topology, the load is always disconnected from the input during shutdown of the converter.

Buck-Boost Operation

To be able to regulate the output voltage properly at all possible input voltage conditions, the device automatically switches from step down operation to boost operation and back as required by the configuration. It always uses one active switch, one rectifying switch, one switch permanently on, and one switch permanently off. Therefore, it operates as a step down converter (buck) when the input voltage is higher than the output voltage, and as a boost converter when the input voltage is lower than the output voltage. There is no mode of operation in which all 4 switches are permanently switching. Controlling the switches this way allows the converter to maintain high efficiency at the most important point of operation; when input voltage is close to the output voltage. The RMS current through the switches and the inductor is kept at a minimum, to minimize switching and conduction losses. Switching losses are also kept low by using only one active and one passive switch. Regarding the remaining 2 switches, one is kept permanently on and the other is kept permanently off, thus causing no switching losses.

Power Save Mode

The PS pin can be used to select different operation modes. To enable power save, PS must be set low. Power save mode is used to improve efficiency at light load. If power save mode is enabled, the converter stops operating if the average inductor current gets lower than about 300 mA and the output voltage is at or above its nominal value. If the output voltage decreases below its nominal value, the device ramps up the output voltage again by starting operation using a programmed average inductor current higher than required by the current load condition. Operation can last for one or several pulses. The converter again stops operating once the conditions for stopping operation are met again.

The power save mode can be disabled by programming high at PS. The PS input supports standard logic threshold voltages. If the device is synchronized to an external clock connected to SYNC, power save mode is disabled.

Synchronization

Connecting a clock signal at SYNC forces the device to synchronize to the connected clock frequency. Synchronization is done by a PLL, so synchronizing to lower and higher frequencies compared to the internal clock works without any issues. The PLL can also tolerate missing clock pulses without the converter malfunctioning. The SYNC input supports standard logic thresholds. If synchronization is not used SYNC must be tied low or connected to GND. Applying a clock signal to SYNC automatically disables the power save mode.

Device Enable

The device is put into operation when EN is set high. It is put into a shutdown mode when EN is set to GND. In shutdown mode, the regulator stops switching, all internal control circuitry is switched off, and the load is disconnected from the input. This also means that the output voltage can drop below the input voltage during shutdown. During start-up of the converter, the duty cycle and the peak current are limited in order to avoid high peak currents flowing from the input.

Output Voltage Selection

To program the output voltage at an adjustable device option, like TPS63010 an external resistive feedback divider, connected to FB must be used. For the fixed output voltage versions, FB is used as an output voltage sense and must be connected to the output voltage VOUT. All fixed output voltage versions have two different output voltages programmed internally. They are selected by programming high or low at VSEL. The higher output voltage is selected by programming VSEL high and the lower output voltage is selected by programming VSEL low. VSEL also supports standard logic thresholds.

Softstart and Short-Circuit Protection

After being enabled, the device starts operating. The average current limit ramps up from an initial 400 mA following the output voltage increasing. At an output voltage of about 1.2 V, the current limit is at its nominal value. If the output voltage does not increase, the current limit will not increase. There is no timer implemented. Thus, the output voltage overshoot at startup, as well as the inrush current, is kept at a minimum. The device ramps up the output voltage in a controlled manner even if a very large capacitor is connected at the output. When the output voltage does not increase above 1.2 V, the device assumes a short-circuit at the output, and keeps the current limit low to protect itself and the application. At a short at the output during operation, the current limit is also decreased accordingly. At 0 V at the output, for example, the output current will not exceed about 400 mA.

Undervoltage Lockout

If the supply voltage on VINA is lower than its approximate threshold (see electrical characteristics table), an undervoltage lockout function prevents device start-up. When in operation, the device automatically enters the shutdown mode if the voltage on VINA drops below the undervoltage lockout threshold. The device automatically restarts if the input voltage recovers to the minimum operating input voltage.

Overtemperature Protection

The device has a built-in temperature sensor which monitors the internal IC temperature. If the temperature exceeds the programmed threshold (see electrical characteristics table), the device stops operating. As soon as the IC temperature has decreased below the programmed threshold, it again starts operating. There is a built-in hysteresis to avoid unstable operation at IC temperatures at the overtemperature threshold.

APPLICATION INFORMATION

DESIGN PROCEDURE

The TPS6301x dc/dc converters are intended for systems powered by one-cell Li-Ion or Li-Polymer battery with a typical voltage between 2.3 V and 4.5 V. They can also be used in systems powered by a double or triple cell Alkaline, NiCd, or NiMH battery with a typical terminal voltage between 2 V and 5.5 V. Additionally, any other voltage source with a typical output voltage between 2 V and 5.5 V can power systems where the TPS6301x is used.

PROGRAMMING THE OUTPUT VOLTAGE

Within the TPS6301X family there are fixed and adjustable output voltage versions available. To properly configure the fixed output voltage devices, the FB pin is used to sense the output voltage. This means that it must be connected directly to VOUT. At the adjustable output voltage versions, an external resistor divider is used to adjust the output voltage. The resistor divider must be connected between VOUT, FB and GND. When the output voltage is regulated properly, the typical value of the voltage at the FB pin is 500 mV. The maximum recommended value for the output voltage is 5.5 V. The current through the resistive divider should be about 100 times greater than the current into the FB pin. The typical current into the FB pin is 0.01 μ A, and the voltage across the resistor between FB and GND, R2, is typically 500 mV. Based on those two values, the recommended value for R2 should be lower than 500 k Ω , in order to set the divider current at 1 μ A or higher. The recommended value for this resistor is in the range of 200 k Ω . From that, the value of the resistor connected between VOUT and FB, R1, depending on the needed output voltage (V_{OUT}), is calculated using Equation 1:

$$R_1 = R_2 \times \left(\frac{V_{OUT}}{V_{FB}} - 1 \right) \quad (1)$$

As an example, if an output voltage of 3.3 V is needed, a 1-M Ω resistor should be chosen for R1.

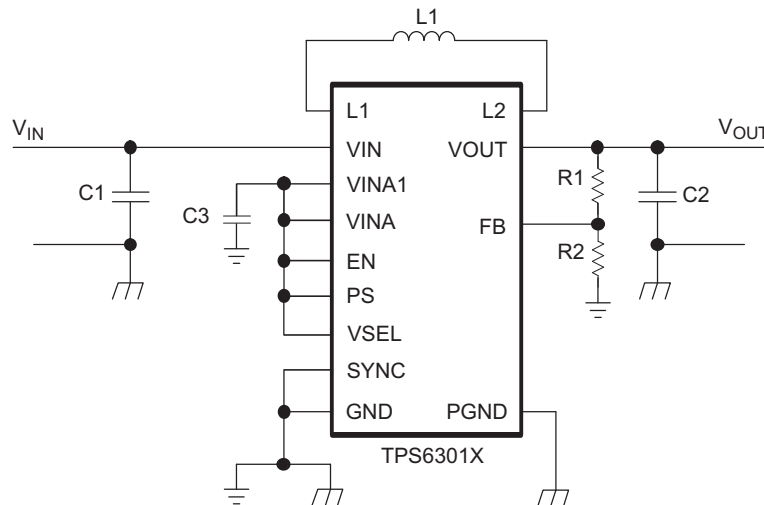

Figure 30. Typical Application Circuit for Adjustable Output Voltage Option

INDUCTOR SELECTION

To properly configure the TPS6301X devices, an inductor must be connected between pin L1 and pin L2. To estimate the inductance value Equation 2 and Equation 3 can be used.

$$L_1 = (V_{IN1} - V_{OUT}) \times 0.5 \times \frac{\mu\text{S}}{\text{A}} \quad (2)$$

$$L_2 = V_{OUT} \times 0.5 \times \frac{\mu\text{S}}{\text{A}} \quad (3)$$

In Equation 2 the minimum inductance value, L_1 for step down mode operation is calculated. V_{IN1} is the

maximum input voltage. In [Equation 3](#) the minimum inductance, L_2 , for boost mode operation is calculated. The recommended minimum inductor value is either L_1 or L_2 whichever is higher. As an example, a suitable inductor for generating 3.3 V from a Li-Ion battery with a battery voltage range from 2.5 V up to 4.2 V is 2.2 μH . The recommended inductor value range is between 1 μH and 4.7 μH . In general, this means that at high voltage conversion rates, higher inductor values offer better performance.

With the chosen inductance value, the peak current for the inductor in steady state operation can be calculated. [Equation 4](#) shows how to calculate the peak current I_1 in step down mode operation and [Equation 5](#) shows how to calculate the peak current I_2 in boost mode operation. $V_{\text{IN}2}$ is the minimum input voltage.

$$I_1 = \frac{I_{\text{OUT}}}{0.8} + \frac{V_{\text{OUT}}(V_{\text{IN}1} - V_{\text{OUT}})}{2 \times V_{\text{IN}1} \times f \times L} \quad (4)$$

$$I_2 = \frac{V_{\text{OUT}} \times I_{\text{OUT}}}{0.8 \times V_{\text{IN}2}} + \frac{V_{\text{IN}2} \times (V_{\text{OUT}} - V_{\text{IN}2})}{2 \times V_{\text{OUT}} \times f \times L} \quad (5)$$

The critical current value for selecting the right inductor is the higher value of I_1 and I_2 . It also needs to be taken into account that load transients and error conditions may cause higher inductor currents. This also needs to be taken into account when selecting an appropriate inductor. The following inductor series from different suppliers have been used with TPS6301x converters:

Table 1. List of Inductors

VENDOR	INDUCTOR SERIES
Coilcraft	LPS3015
	LPS4012
FDK	MIPSA2520
Murata	LQH3NP
	LQM2HP
Toko	FDSE0312

CAPACITOR SELECTION

Input Capacitor

At least a 4.7- μF input capacitor is recommended to improve transient behavior of the regulator and EMI behavior of the total power supply circuit. A ceramic capacitor placed as close as possible to the VIN and PGND pins of the IC is recommended.

Output Capacitor

For the output capacitor, it is recommended to use small ceramic capacitors placed as close as possible to the VOUT and PGND pins of the IC. If, for any reason, the application requires the use of large capacitors which can not be placed close to the IC, using a smaller ceramic capacitor in parallel to the large one is recommended. This small capacitor should be placed as close as possible to the VOUT and PGND pins of the IC.

To get an estimate of the recommended minimum output capacitance, [Equation 6](#) can be used.

$$C_{\text{OUT}} = 5 \times L \times \frac{\mu\text{F}}{\mu\text{H}} \quad (6)$$

A capacitor with a value in the range of the calculated minimum should be used. This is required to maintain control loop stability. There are no additional requirements regarding minimum ESR. There is also no upper limit for the output capacitance value. Larger capacitors will cause lower output voltage ripple as well as lower output voltage drop during load transients.

LAYOUT CONSIDERATIONS

As for all switching power supplies, the layout is an important step in the design, especially at high peak currents and high switching frequencies. If the layout is not carefully done, the regulator could show stability problems as well as EMI problems. Therefore, use wide and short traces for the main current path and for the power ground tracks. The input capacitor, output capacitor, and the inductor should be placed as close as possible to the IC. Use a common ground node for power ground and a different one for control ground to minimize the effects of ground noise. Connect these ground nodes at any place close to one of the ground pins of the IC.

The feedback divider should be placed as close as possible to the control ground pin of the IC. To lay out the control ground, it is recommended to use short traces, separated from the power ground traces. This avoids ground shift problems, which can occur due to superimposition of power ground current and control ground current.

THERMAL INFORMATION

Implementation of integrated circuits in low-profile and fine-pitch surface-mount packages typically requires special attention to power dissipation. Many system-dependent issues such as thermal coupling, airflow, added heat sinks and convection surfaces, and the presence of other heat-generating components affect the power-dissipation limits of a given component.

Three basic approaches for enhancing thermal performance are listed below.

1. Improving the power dissipation capability of the PCB design
2. Improving the thermal coupling of the component to the PCB by soldering all pins to traces as wide as possible.
3. Introducing airflow in the system

The maximum recommended junction temperature (T_J) of the TPS6301x devices is 125°C. The thermal resistance of this 20-pin chip-scale package (YFF) is $R_{\theta JA} = 84^\circ\text{C}/\text{W}$, if all pins are soldered. Specified regulator operation is assured to a maximum ambient temperature T_A of 85°C. Therefore, the maximum power dissipation is about 476 mW, as calculated in [Equation 7](#). More power can be dissipated if the maximum ambient temperature of the application is lower.

$$P_{D(\text{MAX})} = \frac{T_{J(\text{MAX})} - T_A}{R_{\theta JA}} = \frac{125^\circ\text{C} - 85^\circ\text{C}}{84^\circ\text{C}/\text{W}} = 476 \text{ mW} \quad (7)$$

PACKAGE INFORMATION

Package Dimensions

The package dimensions for this YFF package are shown in the table below. See the package drawing at the end of this data sheet for more details.

YFF Package Dimensions

Packaged Devices	D	E
TPS63010YFF	2.14 ± 0.05 mm	1.93 ± 0.05 mm

PACKAGING INFORMATION

Orderable Device	Status ⁽¹⁾	Package Type	Package Drawing	Pins	Package Qty	Eco Plan ⁽²⁾	Lead/Ball Finish	MSL Peak Temp ⁽³⁾
TPS63010YFFR	ACTIVE	DSBGA	YFF	20	3000	Green (RoHS & no Sb/Br)	SNAGCU	Level-1-260C-UNLIM
TPS63010YFFT	ACTIVE	DSBGA	YFF	20	250	Green (RoHS & no Sb/Br)	SNAGCU	Level-1-260C-UNLIM
TPS63011YFFR	ACTIVE	DSBGA	YFF	20	3000	Green (RoHS & no Sb/Br)	SNAGCU	Level-1-260C-UNLIM
TPS63011YFFT	ACTIVE	DSBGA	YFF	20	250	Green (RoHS & no Sb/Br)	SNAGCU	Level-1-260C-UNLIM
TPS63012YFFR	ACTIVE	DSBGA	YFF	20	3000	Green (RoHS & no Sb/Br)	SNAGCU	Level-1-260C-UNLIM
TPS63012YFFT	ACTIVE	DSBGA	YFF	20	250	Green (RoHS & no Sb/Br)	SNAGCU	Level-1-260C-UNLIM

⁽¹⁾ The marketing status values are defined as follows:

ACTIVE: Product device recommended for new designs.

LIFEBUY: TI has announced that the device will be discontinued, and a lifetime-buy period is in effect.

NRND: Not recommended for new designs. Device is in production to support existing customers, but TI does not recommend using this part in a new design.

PREVIEW: Device has been announced but is not in production. Samples may or may not be available.

OBSOLETE: TI has discontinued the production of the device.

⁽²⁾ Eco Plan - The planned eco-friendly classification: Pb-Free (RoHS), Pb-Free (RoHS Exempt), or Green (RoHS & no Sb/Br) - please check <http://www.ti.com/productcontent> for the latest availability information and additional product content details.

TBD: The Pb-Free/Green conversion plan has not been defined.

Pb-Free (RoHS): TI's terms "Lead-Free" or "Pb-Free" mean semiconductor products that are compatible with the current RoHS requirements for all 6 substances, including the requirement that lead not exceed 0.1% by weight in homogeneous materials. Where designed to be soldered at high temperatures, TI Pb-Free products are suitable for use in specified lead-free processes.

Pb-Free (RoHS Exempt): This component has a RoHS exemption for either 1) lead-based flip-chip solder bumps used between the die and package, or 2) lead-based die adhesive used between the die and leadframe. The component is otherwise considered Pb-Free (RoHS compatible) as defined above.

Green (RoHS & no Sb/Br): TI defines "Green" to mean Pb-Free (RoHS compatible), and free of Bromine (Br) and Antimony (Sb) based flame retardants (Br or Sb do not exceed 0.1% by weight in homogeneous material)

⁽³⁾ MSL, Peak Temp. -- The Moisture Sensitivity Level rating according to the JEDEC industry standard classifications, and peak solder temperature.

Important Information and Disclaimer:The information provided on this page represents TI's knowledge and belief as of the date that it is provided. TI bases its knowledge and belief on information provided by third parties, and makes no representation or warranty as to the accuracy of such information. Efforts are underway to better integrate information from third parties. TI has taken and continues to take reasonable steps to provide representative and accurate information but may not have conducted destructive testing or chemical analysis on incoming materials and chemicals. TI and TI suppliers consider certain information to be proprietary, and thus CAS numbers and other limited information may not be available for release.

In no event shall TI's liability arising out of such information exceed the total purchase price of the TI part(s) at issue in this document sold by TI to Customer on an annual basis.

TAPE AND REEL INFORMATION



QUADRANT ASSIGNMENTS FOR PIN 1 ORIENTATION IN TAPE



*All dimensions are nominal

Device	Package Type	Package Drawing	Pins	SPQ	Reel Diameter (mm)	Reel Width W1 (mm)	A0 (mm)	B0 (mm)	K0 (mm)	P1 (mm)	W (mm)	Pin1 Quadrant
TPS63010YFFR	DSBGA	YFF	20	3000	180.0	8.4	2.2	2.35	0.8	4.0	8.0	Q1
TPS63010YFFT	DSBGA	YFF	20	250	180.0	8.4	2.2	2.35	0.8	4.0	8.0	Q1
TPS63012YFFR	DSBGA	YFF	20	3000	180.0	8.4	2.2	2.35	0.8	4.0	8.0	Q1
TPS63012YFFT	DSBGA	YFF	20	250	180.0	8.4	2.2	2.35	0.8	4.0	8.0	Q1

TAPE AND REEL BOX DIMENSIONS



*All dimensions are nominal

Device	Package Type	Package Drawing	Pins	SPQ	Length (mm)	Width (mm)	Height (mm)
TPS63010YFFR	DSBGA	YFF	20	3000	190.5	212.7	31.8
TPS63010YFFT	DSBGA	YFF	20	250	190.5	212.7	31.8
TPS63012YFFR	DSBGA	YFF	20	3000	190.5	212.7	31.8
TPS63012YFFT	DSBGA	YFF	20	250	190.5	212.7	31.8

YFF (R-XBGA-N20)

DIE-SIZE BALL GRID ARRAY

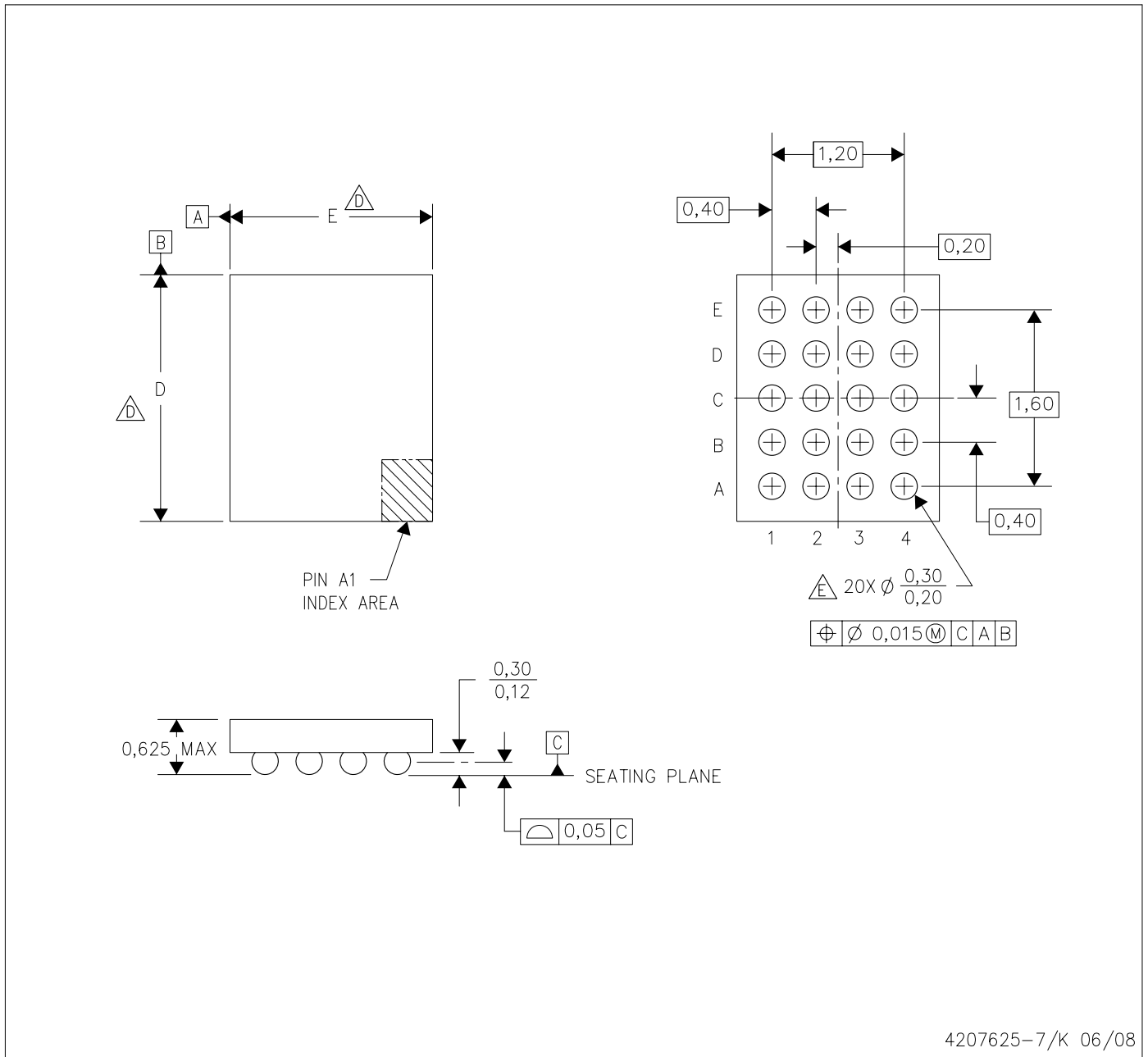

- NOTES:
- A. All linear dimensions are in millimeters.
 - B. This drawing is subject to change without notice.
 - C. NanoFree™ package configuration.
 - \triangle Devices in YFF package can have dimension D ranging from 1.96 to 2.65 mm and dimension E ranging from 1.56 to 2.25mm. To determine the exact package size of a particular device, refer to the device datasheet or contact a local TI representative.
 - E. Reference Product Data Sheet for array population.
5 x 4 matrix pattern is shown for illustration only.
 - F. This package contains lead-free balls.

NanoFree is a trademark of Texas Instruments.

IMPORTANT NOTICE

Texas Instruments Incorporated and its subsidiaries (TI) reserve the right to make corrections, modifications, enhancements, improvements, and other changes to its products and services at any time and to discontinue any product or service without notice. Customers should obtain the latest relevant information before placing orders and should verify that such information is current and complete. All products are sold subject to TI's terms and conditions of sale supplied at the time of order acknowledgment.

TI warrants performance of its hardware products to the specifications applicable at the time of sale in accordance with TI's standard warranty. Testing and other quality control techniques are used to the extent TI deems necessary to support this warranty. Except where mandated by government requirements, testing of all parameters of each product is not necessarily performed.

TI assumes no liability for applications assistance or customer product design. Customers are responsible for their products and applications using TI components. To minimize the risks associated with customer products and applications, customers should provide adequate design and operating safeguards.

TI does not warrant or represent that any license, either express or implied, is granted under any TI patent right, copyright, mask work right, or other TI intellectual property right relating to any combination, machine, or process in which TI products or services are used. Information published by TI regarding third-party products or services does not constitute a license from TI to use such products or services or a warranty or endorsement thereof. Use of such information may require a license from a third party under the patents or other intellectual property of the third party, or a license from TI under the patents or other intellectual property of TI.

Reproduction of TI information in TI data books or data sheets is permissible only if reproduction is without alteration and is accompanied by all associated warranties, conditions, limitations, and notices. Reproduction of this information with alteration is an unfair and deceptive business practice. TI is not responsible or liable for such altered documentation. Information of third parties may be subject to additional restrictions.

Resale of TI products or services with statements different from or beyond the parameters stated by TI for that product or service voids all express and any implied warranties for the associated TI product or service and is an unfair and deceptive business practice. TI is not responsible or liable for any such statements.

TI products are not authorized for use in safety-critical applications (such as life support) where a failure of the TI product would reasonably be expected to cause severe personal injury or death, unless officers of the parties have executed an agreement specifically governing such use. Buyers represent that they have all necessary expertise in the safety and regulatory ramifications of their applications, and acknowledge and agree that they are solely responsible for all legal, regulatory and safety-related requirements concerning their products and any use of TI products in such safety-critical applications, notwithstanding any applications-related information or support that may be provided by TI. Further, Buyers must fully indemnify TI and its representatives against any damages arising out of the use of TI products in such safety-critical applications.

TI products are neither designed nor intended for use in military/aerospace applications or environments unless the TI products are specifically designated by TI as military-grade or "enhanced plastic." Only products designated by TI as military-grade meet military specifications. Buyers acknowledge and agree that any such use of TI products which TI has not designated as military-grade is solely at the Buyer's risk, and that they are solely responsible for compliance with all legal and regulatory requirements in connection with such use.

TI products are neither designed nor intended for use in automotive applications or environments unless the specific TI products are designated by TI as compliant with ISO/TS 16949 requirements. Buyers acknowledge and agree that, if they use any non-designated products in automotive applications, TI will not be responsible for any failure to meet such requirements.

Following are URLs where you can obtain information on other Texas Instruments products and application solutions:

Products

Amplifiers	amplifier.ti.com
Data Converters	dataconverter.ti.com
DSP	dsp.ti.com
Clocks and Timers	www.ti.com/clocks
Interface	interface.ti.com
Logic	logic.ti.com
Power Mgmt	power.ti.com
Microcontrollers	microcontroller.ti.com
RFID	www.ti-rfid.com
RF/IF and ZigBee® Solutions	www.ti.com/lprf

Applications

Audio	www.ti.com/audio
Automotive	www.ti.com/automotive
Broadband	www.ti.com/broadband
Digital Control	www.ti.com/digitalcontrol
Medical	www.ti.com/medical
Military	www.ti.com/military
Optical Networking	www.ti.com/opticalnetwork
Security	www.ti.com/security
Telephony	www.ti.com/telephony
Video & Imaging	www.ti.com/video
Wireless	www.ti.com/wireless

Mailing Address: Texas Instruments, Post Office Box 655303, Dallas, Texas 75265
Copyright © 2008, Texas Instruments Incorporated